















TOUGHER FASTER SMARTER



CUSTOM APPLICATION CATALOG

*For Hand-held and
Machine Mounted
Nailers and Staplers*

	Depth of Drive	_____	PG.4
	Auxiliary Handles	_____	PG.6
	Tool Suspension	_____	PG.8
	Standard Valve Options	_____	PG.10
	Remote Valves	_____	PG.12
	High Capacity Magazines	_____	PG.16

	Machine Mounted Tools	_____	PG.18
	Air Flow Upgrades	_____	PG.22
	Standard Magazine Assemblies	_____	PG.24
	Fastener Driving Guides	_____	PG.26
	Miscellaneous Accessories	_____	PG.28
	Useful Information	_____	PG.30

Depth of Drive Kits

Options for Industrial use tools.

- ✓ “Tool-Free” for frequent application changes like fastener length, materials being fastened, and air pressure.
- ✓ “Set and Lock” for less changes and more demanding applications.



Part NO.	Description	Compatibility	
107905	Tool-Free DOD Kit	PN51B / SCN51	
120074	Tool-Free DOD	PN57B, PN58	
101284	Set and Lock with Tool	PN57B, PN58	
101710	Set and Lock with Tool	PN59	
101485	Set and Lock with Tool	PN65	
101714	Set and Lock with Tool	PN70	
106539	Tool-Free DOD Kit	FSN2283A / FSN2283AD	

Auxiliary Handles

- ✓ Secondary Handles convert tools to two-handed operation.
- ✓ Walking Stick Extension Handle allows longer reach applications such as subfloors, corrugate to wood, and deep crating.



Part NO.	Description	Compatibility
101022	Secondary Handle, Engages Contact Trip includes Modified Trip Cover	PN57B, PN58, PN59
105961	Secondary Handle, Engages Contact Trip includes Modified Trip Cover	PN65M
101025	Secondary Handle, Engages Contact Trip includes Modified Trip Cover	PN70,PN80
101048	Secondary Handle, Engages Contact Trip includes Modified Trip Cover	PN100
107719	Secondary Handle, Engages Contact Trip includes Modified Trip Cover	PN90
108881	Secondary Handle, Engages Contact Trip includes Modified Trip Cover	PN130,PN130B

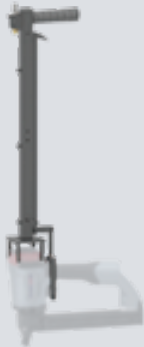

Part NO.	Description	Compatibility
120199	Walking Stick, Extension Handle	SN40, SN50



Part NO.	Description	Compatibility
SN32-590W	Walking Stick Stapler, Complete Tool	590 Series Staples 15/16" Crown 5/8" ~ 1-1/4" Leg Length

Tool Suspension

Targeted for dedicated flat or vertical workstations.

- ✓ Cable sets with eyelets are ideal for flat workstations where tools fire vertically.
- ✓ Cable sets without eyelets offer more mobility and accommodate varying tool firing angles.

Part NO.	Description	Compatibility	
103244	Cable Set with eyelets Smaller Body Tools	PN57B, PN58, PN59, PN65, PN70, PN80, SN40, SN50, CFN-15S	 
100603	Cable Set with eyelets Larger Body Tools	PN90, PN100, PN130, FSN130, FSN160, FSN2283, FSN3490, FCN90, FCN90LB, SCN90L	 
103413	Cable Set no eyelets	PN57B, PN58, PN59, PN65, PN70, PN80, PN90, PN100, FSN2283, FSN3490, FCN90LB, SCN90L, FCN90, SCN65, FCN90, SN50, SN40, included with PN100CP	 
101960	Steel Hanger	PN70, PN80 included on PN70CL	 
CB3-5	Counter Balancer 6.6lbs to 11lbs (3 to 5 kgs)		
CB5-7	Counter Balancer 11lbs to 15.5lbs (5 to 7 kgs)		
CB5-9	Counter Balancer 11lbs to 19.8lbs (5 to 9 kgs)		
CB9-15	Counter Balancer 19.8lbs to 33lbs (9 to 15 kgs)		







Standard Valve Options



Valves can be ordered from the factory installed or as accessories for conversion in the field.

Auto-Fire valves have adjustable rates of fire.

Sequential Kits: convert any tool to from Contact to Sequential fire for operation.









Part NO.	Description	Compatibility		
106548	Trigger Operated Conversion Kit	FS9040		
106549	Trigger Operated Conversion Kit	FS9240		
106550	Trigger Operated Conversion Kit	FN1850		









Part NO.	Description	Compatibility		
104466	Auto-Fire Valve 2-20 Cycles / Second	SN40 Series		
104465	Auto-Fire Valve 2-20 Cycles / Second	SN50 Series		
105289	Auto-Fire Valve 2-20 Cycles / Second	SN41 Series		
100453	Sequential Kit (SEQ 1)	PN51, PN57B, PN58, PN65, PN70, PN80, PN90, PN100, PN130, SCN51, SCN90, SN40, SN50, FSN3490, FSN34100, FSN130, FSN160, FCN90B, FCN90LB		
103428	Sequential Kit	FSN2283		
104050	Sequential Kit	MCN40B		
106593	Sequential Kit	SCN65, SCN66		
120143	Sequential Kit (SEQ 6)	SN41 Series, PN51, PN57B, PN58, PN65, PN70, PN80, PN90, PN100, PN130, SCN90, SN40, SN50, FSN130, FSN160, FCN90LB		
105477	Sequential Kit	FS9040, FS9240, FN1850, FS9240BC		
101467	Trip Guide, Trigger Operated SN Series Staplers	SN40, SN50 Series		

Remote Valves

Designed for machine mounted tools and can be ordered as accessories or installed at the factory.

- ✓ Positive Actuation: receives air to fire
- ✓ Negative Actuation: evacuate air to fire
- ✓ Electric Actuation: requires additional components (not included)
- ✓ Trigger Block: lower trip components, trigger and trigger valve remain intact

Part NO.	Description	Compatibility	
103956	RCVA1 Remote Control Valve Actuation: Negative Pressure Connection: 4mm, straight	PN51, PN57B, PN58, PN65, PN70, PN80, PN90, PN100, PN130, SCN90, SN40, SN50, FSN3490, FSN34100, FSN130, FSN160 Bostitch: TVA Max: RCV70	
103440	RCVA2 Remote Control Valve Actuation: Negative Pressure Connection: 4mm, 90° elbow	PN51, PN57B, PN58, PN65, PN70, PN80, PN90, PN100, PN130, SCN90, SN40, SN50, FSN3490, FSN34100, FSN130, FSN160 Bostitch: TVA4 Max: RCV70	
120220	RCVA3 Remote Control Valve Actuation: Positive Pressure Connection: 6mm, 90° elbow	PN51, PN57B, PN58, PN65, PN70, PN80, PN90, PN100, PN130, SCN90, SN40, SN50, FSN3490, FSN34100, FSN130, FSN160	
120083	Remote Control Valve Kit (TVA 2) Actuation: Electric (Mac Valve not included)	PN51, PN57B, PN58, PN65, PN70, PN80, PN90, PN100, PN130, SCN90, SN40, SN50, FSN3490, FSN34100, FSN130, FSN160 Bostitch: TVA2	
105291	SN41 Remote Fire Valve (Valve Only) Actuation: Negative Pressure Connection: 4mm, Straight	SN41 Bostitch: TVA12RF	
103184	RCVA2 Elbow Fitting, 90° Connection: 6mm	Compatible with valves: 103956, 103440	
120131	RCVA2 Elbow Fitting, 90° Connection: 4mm	Compatible with valves: 103956, 103440	
106327	RCVA3-F remote valve Actuation: Positive Pressure	FS9040 / FS9240 / FN1850 / FSM40 Paslode F-350S	
120369	Remote fire valve for AFN1565: Positive Pressure	AFN1565	

Part NO.	Description	Compatibility	
104994	RCVA2 Elbow Fitting, 90° Connection: 6mm	PN51, PN57B, PN58, PN65, PN70, PN80, PN90, PN100, PN130, SCN90, SN40, SN50, FSN3490, FSN34100, FSN130, FSN160 Bostitch: TVA4 Max: RCV70	
100281	RCVA2 Straight Fitting Connection: 4mm	Compatible with valves: 103956, 103440	
107283	TVA2-F 18ga Tool Remote Valve Actuation: Positive	FN1850, FS9040, FS9240 Paslode: 1X0713 Mac Valve 35 Series (not included)	
XM10696	PS50 Remote Control Trigger Valve Actuation: Positive Pressure Connection: 6mm	PS50 Series	
104891	Remote Trigger Block Actuation: Positive Pressure	SN40, SN50 Series	
106457	Remote Trigger Block Actuation: Positive Pressure	PN90, FCN90, FSN34100, FSN3490	
107860	Remote Trigger Block Actuation: Positive Pressure	PN100	
108971	Remote Trigger Block Actuation: Positive Pressure	FN1665	
104865	Remote Trigger Block Actuation: Positive Pressure	FSN2283	

MAKE AUTOMATION SIMPLE WITH **EVERWIN**



*Ask about our plug n' play solutions
that allow you to automate
more than 300 different tool models*

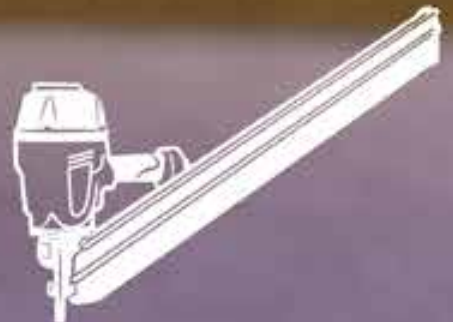
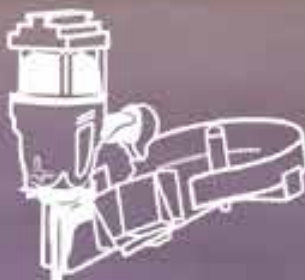

High Capacity Magazines Kits

Less reloading in high volume applications.

- ✓ Available to order installed on new tools for machine mounting or hand-held use or as a kit to retrofit existing tools.

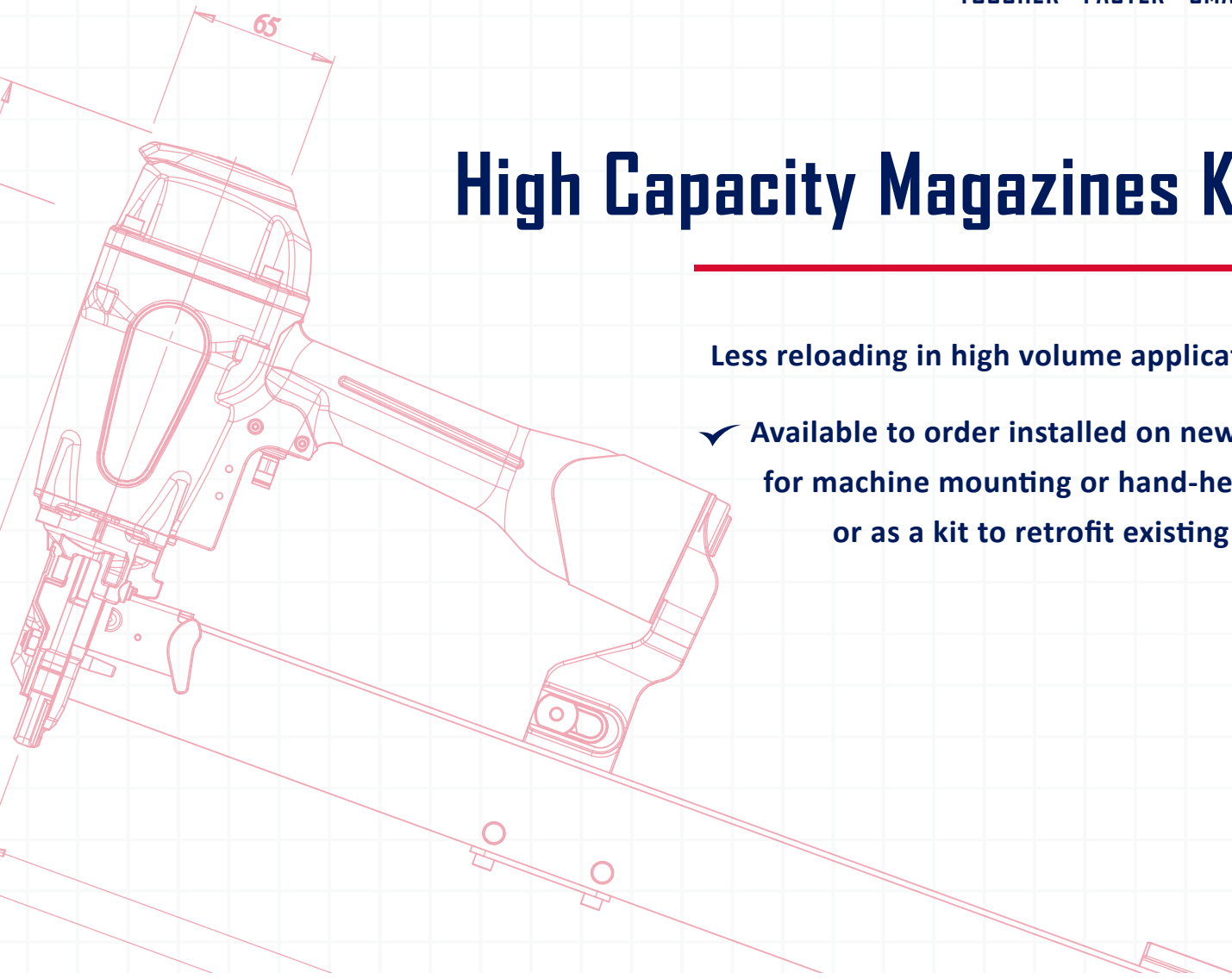

Part NO.	Description	Compatibility	
103467	S4 / N Wire, 1/2" Crown, Double Length Magazine Magazine Capacity: 360	SN50S4	
103468	S5 / N Wire, 7/16" Crown, Double Length Magazine Magazine Capacity: 360	SN50S5	
103469	S5 / N Wire, 7/16" Crown, Triple Length Magazine Magazine Capacity: 480	SN50S5	
107259	Senco P Wire, 1-1/16" Crown, Double Length Magazine Magazine Capacity: 360	SN402P	

Part NO.	Description	Compatibility	
106538	Bostitch S2 Wire, 1" Crown, Double Length Magazine Magazine Capacity: 360	SN402S2	
109446	Bostitch S2 Wire, 1" Crown, Double Length Magazine Magazine Capacity: 360	SN412S2	
108437	34° Papertape Strip Magazine Kit, 4" Max, Double Length Magazine Capacity: 180	FSN34100	
107917	21° Plastic Strip Nailer Magazine Capacity: 110	FSN130	
107918	21° Plastic Strip Nailer Magazine Capacity: 110	FSN160	
109387	Automation tool mount (AFN1565)	AFN1565	
109388	Automation tool mount (FS9040)	FS9040	
109389	Automation tool mount (FN1665)	FN1665	

Machine Mounted Tools

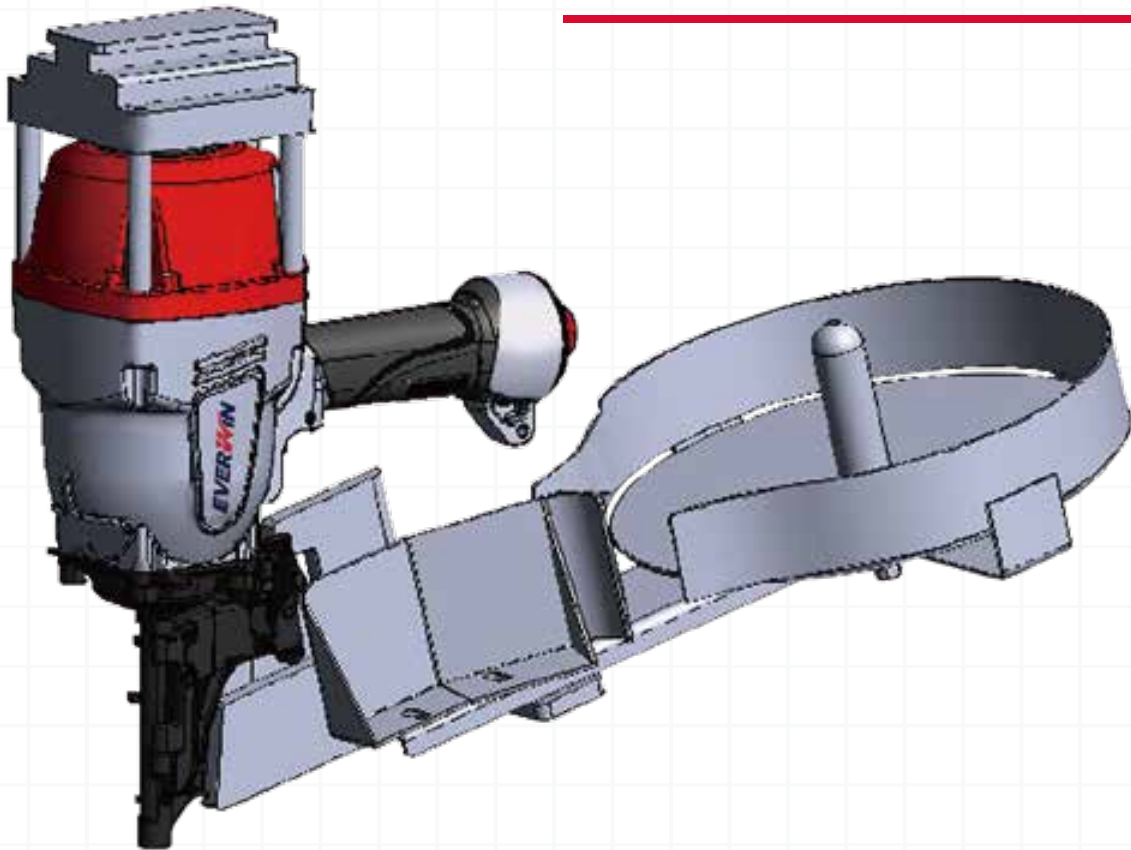

- ✓ **"PAL"** tools do not include magazines but come stock with remote trigger valves.
- ✓ Select **"PAL"** models come with high flow head valves, high flow driver guides, and double feed springs.
- ✓ **"LM"** tools can be used in machine mounted or hand-held applications and ordered with remote valve options.
- ✓ **"JM"** tools are for machine mounted applications and include remote trigger valves.
- ✓ All tools can be custom ordered from the factory with various remote valve options.

Part NO.	Description	Compatibility	
PN57BPAL	15° Wire Coil Machine Mounted Nailer No Magazine Includes Remote Valve: RCVA1 (neg.)	.083"-.090" Diameter 1" - 2 1/4"	
PN58PAL	15° Wire Coil Machine Mounted Nailer (+13% more power vs PN57-PAL) No Magazine Includes Remote Valve: RCVA1 (neg.)	.083"-.090" Diameter 1" - 2 1/4"	
PN70PAL	15° Wire Coil Machine Mounted Nailer No Magazine Includes Remote Valve: RCVA1 (neg.)	.099"-.113" Diameter 1 3/4" - 2 3/4"	
PN80PAL	15° Wire Coil Machine Mounted Nailer No Magazine Includes Remote Valve: RCVA1 (neg.)	.099"-.131" Diameter 2" - 3 1/4"	
PN90PAL	15° Wire Coil Machine Mounted Nailer (+25% more power vs PN80-PAL) No Magazine Includes Remote Valve: RCVA1 (neg.)	.099"-.148" Diameter 2" - 3 1/2"	
PN100B-PAL	15° Wire Coil Machine Mounted Nailer (+25% more power vs PN90-PAL) No Magazine Includes Remote Valve: RCVA1 (neg.)	.099"-.131" Diameter 2 1/2" - 4"	
SN40 / SN50 LM	Magazine Options: S4 / N Wire, 1/2" Crown, Double Length S5 / N Wire, 7/16" Crown, Double Length S5 / N Wire, 7/16" Crown, Triple Length	16 / 17 GA Staples	
FSN34100-LM	34° Papertape Strip Nailer Magazine Capacity: 180 Includes Remote Valve: RCVA1 (neg.)	.113"-.131" Diameter 2" - 4"	





Front Mount Style



(750 pc load)



(3000 pc load)

Component	Part NO.	Description	Fits
Front Mount Assembly 	120419	Cradle Mount / Bumper / Bolts	PN57B / MAX CN55 / Bostitch N58C
	120427	Cradle Mount / Bumper / Bolts	PN65M
	120414	Cradle Mount / Bumper / Bolts	PN70 / PN80 / MAX CN70/80 / Bostitch N71
	120416	Cradle Mount / Bumper / Bolts	PN90
	120420	Cradle Mount / Bumper / Bolts	PN100B / MAX CN100
Arm & Magazine 	120421	Arm / Magazine (750pc)	PN57,PN65M,PN70,PN80
	120422	Arm / Magazine (750pc)	PN90
	120423	Arm / Magazine (750pc)	PN100B / MAX CN100
	120415	Arm / Magazine (3000pc)	PN57,PN65M,PN70,PN80,PN90
	120424	Arm / Magazine (3000pc)	PN100B / MAX CN100
Complete assembly  	120428	Mount / Arm / Chute / Magazine (750pcs)	PN57B / MAX CN55 / Bostitch N58C
	120429	Mount / Arm / Chute / Magazine (750pcs)	PN65M
	120430	Mount / Arm / Chute / Magazine (750pcs)	PN70 / PN80 / MAX CN70/80 / Bostitch N71
	120431	Mount / Arm / Chute / Magazine (750pcs)	PN90
	120432	Mount / Arm / Chute / Magazine (750pcs)	PN100B / MAX CN100
	120433	Mount / Arm / Chute / Magazine (3000pcs)	PN57B / MAX CN55 / Bostitch N58C
	120434	Mount / Arm / Chute / Magazine (3000pcs)	PN65M
	120435	Mount / Arm / Chute / Magazine (3000pcs)	PN70 / PN80 / MAX CN70/80 / Bostitch N71
	120436	Mount / Arm / Chute / Magazine (3000pcs)	PN90
	120437	Mount / Arm / Chute / Magazine (3000pcs)	PN100B / MAX CN100



Nose Mount Nail chute



Part NO.	Description	Compatibility
120317	PN57B/PN58 Nose Mount Nail chute	PN57B/PN58
120425	PN65 Nose Mount Nail chute	PN65
120315	PN70/PN80 Nose Mount Nail chute	PN70/PN80
120357	PN90 Nose Mount Nail chute	PN90
120426	PN100 Nose Mount Nail chute	PN100

Swan Triad Style



(750 pc load)



(3000 pc load)

Component	Part NO.	Description	Fits
Mount Assembly 	120446	Mount / Spacer / Bolts	PN57B / MAX CN55 / Bostitch N58C
	120447	Mount / Spacer / Bolts	PN65M
	120439	Mount / Spacer / Bolts	PN70 / PN80 / MAX CN70/80 / Bostitch N71
	120438	Mount / Spacer / Bolts	PN90
	120448	Mount / Spacer / Bolts	PN100B / MAX CN100
Arm & Magazine  	120449	Arm / Chute/ Magazine (750pc)	PN57B / MAX CN55 / Bostitch N58C
	120451	Arm / Chute/ Magazine (750pc)	PN65M
	120442	Arm / Chute/ Magazine (750pc)	PN70 / PN80 / MAX CN70/80 / Bostitch N71
	120440	Arm / Chute/ Magazine (750pc)	PN90
	120453	Arm / Chute/ Magazine (750pc)	PN100B / MAX CN100
	120450	Arm / Chute/ Magazine (3000pcs)	PN57B / MAX CN55 / Bostitch N58C
	120452	Arm / Chute/ Magazine (3000pcs)	PN65M
	120443	Arm / Chute/ Magazine (3000pcs)	PN70 / PN80 / MAX CN70/80 / Bostitch N71
	120441	Arm / Chute/ Magazine (3000pcs)	PN90
	120454	Arm / Chute/ Magazine (3000pcs)	PN100B / MAX CN100
Complete assembly  	120455	Mount / Arm / Chute / Magazine (750pcs)	PN57B / MAX CN55 / Bostitch N58C
	120456	Mount / Arm / Chute / Magazine (750pcs)	PN65M
	120444	Mount / Arm / Chute / Magazine (750pcs)	PN70 / PN80 / MAX CN70/80 / Bostitch N71
	120417	Mount / Arm / Chute / Magazine (750pcs)	PN90
	120457	Mount / Arm / Chute / Magazine (750pcs)	PN100B / MAX CN100
	120458	Mount / Arm / Chute / Magazine (3000pcs)	PN57B / MAX CN55 / Bostitch N58C
	120459	Mount / Arm / Chute / Magazine (3000pcs)	PN65M
	120445	Mount / Arm / Chute / Magazine (3000pcs)	PN70 / PN80 / MAX CN70/80 / Bostitch N71
	120418	Mount / Arm / Chute / Magazine (3000pcs)	PN90
	120460	Mount / Arm / Chute / Magazine (3000pcs)	PN100B / MAX CN100









Air Flow Upgrades

Volume extenders store more air in the tool, maintaining a higher pressure available during the cycle.

This helps prevent stair stepping of fasteners at high speed.

High Flow End Caps accommodate larger air fittings to improve air flow for more demanding applications and can be mated with Volume Extenders.



Part NO.	Description	Compatibility	
100227	50mm Volume Extender (155c.c.) Estimated 4-5% energy increase	PN70, PN80	
100228	70mm Volume Extender (222c.c.)	PN70, PN80	
100230	50mm Volume Extender (64c.c.) Estimated 4-5% energy increase	PN57B, PN58, PN59 SCN65C, SCN66	
100231	70mm Volume Extender (93c.c.) Estimated 4-5% energy increase	PN57B, PN58, PN59 SCN65C, SCN66	
106941	50mm Volume Extender (150c.c.) Estimated 4-5% energy increase Includes: orings, 3/8" NPT End Cap	PN65M, PN90, PN100, PN130, FCN90B, FCN90L, SCN90L, FSN3490, FSN34100, FSN130, FSN160	
101867	3/8" NPT, End Cap	PN70, PN80 (Included on PN70CL, PN70PAL, PN80PAL)	
101872	3/8" NPT, End Cap	PN90, PN100, FCN90B, FCN90L, SCN90L, PN130, FSN3490, FSN34100, FSN130, FSN160	

Standard Magazine Assemblies

- ✓ Stock, standard capacity magazine components that come fully assembled.
- ✓ Ideal for machine mounted or hand-held tools where less down time is essential



Standard Coil Magazine Assembly



Part NO.	Compatibility
103835	PN57B, PN58 PN59 / Max: CN55
103836	PN65, PN65M
103837	PN70 / Bostitch: N70C / Max: CN70
103838	PN80 / Bostitch: N80CB / Max: CN80
103839	PN100(B)(EPAL) / Max: CN100
103841	PN100CP
104681	FCN90L(B)
104979	FCN90, PN90
105912	PN130B / Bostitch: N512C
103843	SCN65
108666	RCN45

Standard Strup Magazine Assembly



Part NO.	Compatibility
103589	FSN2283
107874	FSN3490
106537	MCN40B
106535	FSN130
106536	FSN160
108438	FSN34100

Fastener Driving Guides

Accurate fastener placement in high volume applications.



Part NO.	Description	Compatibility		
101675	SN40 Gliding Tip for skid-firing and tool mobility	SN40 Series		
108670	SN41S5 CLIP KIT (furniture)	SN41S5 / Bostitch® 438S5		
104859	Vinyl siding, Lower Contact Arm	SN50 Series		
108781	SN50 Series Nose Angle Kit For X Jamb	SN50S5, SN40S4, SN50GSI,SN50GS-14, SN50GS-16		
108143	Vinyl siding, Lower Contact Arm	FS9240, FSM40		

Miscellaneous Accessories

Custom components for dedicated applications.



Part NO.	Description	Compatibility	
101490	PN100 Spacer installed under magazine plate to boost nailing consistency & tool longevity when using 3" nails	PN100, PN100EPAL	
101586	Shroud Kit PN100	PN100, PN100EPAL	
103837	Shroud Kit PN57	PN57B, PN58, PN59	
104806	PN100B nose guide (block) for 3" Length Nails	PN100, PN100EPAL	
108282	Belt hook assembly	PN51, PN57, PN58, PN59, SCN51, SCN65, SCN66, MCN40	
108284	Belt hook assembly	PN65M, MCN65, PN90, FCN90B, FCN90LB, SCN90L, FSN3490, PN100, PN130, FSN130	
107909	PN57/58 Full Wrap Skid Firing Contact Trip	PN57B / PN58 / MAX CN55 / Bostitch N58	
EVERWINSAFE	EVERWIN Pneumatic Nailer / Stapler Safety Training Kit	Certificates, Flyer, Poster (English / spanish)	  
104612	Field Service Guage: Driver Sizer, Nail Guage	ALL MODELS	

Useful Information

GAUGE	CROWN WIDTH	EVERWIN	ATRO	BEA	BOSTITCH	DUD-FAST	HAUBOLD	ISABERG RAPID	KIHLBERG	OMER	PASLODE	PREBENA	SENGO
22	9.1mm (3/8")	US7116	7	71		7	7100		670	3G		V	C
22	4.1mm (5/32")	USSJK16	SJK		SJ 3020					SJK		TK	
22	12.55mm (1/2")	US6416	6(63)	72	SB 3023	30	1800			64		AB	
21	5.4mm (7/32")	US9916	99							99		ED	
21	4.5mm (3/16")	US9716		97	SX 4023					4097		0	
21	4.8mm (3/16")	USSNCW16	93				4000		690	40		TB	W
21	12.3mm (1/2")	US8416	84		SBNK	84				84		AD	
21	12.8mm (1/2")	US8016	8 (80)	80-380	86 / AZ33	80	800		680	80		A	AT
20	12.55mm (1/2")	US50(95)16		95		50	900			50		D	
20	10.8mm (7/16")	USA1116						A11 (140)		T50		PF	H
20	13.1mm (1/2")	P88SJ	88							88			
19	12.3mm (1/2")	PS50-779				65	9000		779	65			
18	13.1mm (1/2")	P110SJ	110							110			
18	5.8mm (1/4")	FS9040	90	90 / 190	SX	18	6000		781	90		E	L
18	8.6mm (5/16")	FS9240	92	92 / 192	SL 5035				664	92		H	
18	9.5mm (3/8")	FSM40				W 18			782	SG		G	M
16&17	10.6-11.1mm (7/16")	SN41S5 SN50S5	100	155 14	S5				783	M2		L	N
16	11.2mm (7/16")	SN50GSI				76	KG 700			700	GSI 16	Z	
16	12.5mm (1/2")	SN41S4 SN50S4	16 NC		BCS 4					S4		S	
16	12.8mm (1/2")	SN50GS16								1016	GS 16		
16	23.8mm (15/16")	SN40GSW					BK 3200			WK	GSW 16	WT	
16	25.4mm (1")	SN41S2 SN40S2	16 WC		BCS 2				654	WS		WC	
16	26.4mm (1-1/16")	SN40P				17			784	WP		WS	P
15	11.3mm (0.44")	SN65Q	18 NC	180			HD 7900			M3		Q	Q

Useful Information

CROWN WIDTH	EVERWIN	ATRO	BEA	BOSTITCH	DUO-FAST	HAUBOLD	ISABERG RAPID	KIHLBERG	OMER	PASLODE	PREBENA	SENGO
12.3mm (1/2")	PS50-777							777	77K			
12.95mm (1/2")	PS550-10B			SB103020					BA			
24mm (15/16")	SN32-590W PS32-590							590	590			

CCA / MCS / RCC / JCC series

Clinching Carton Closers

32mm (1-1/4")	19-32 22-32	16 WC C	32	BCS 2				654 561	WS 32		WC R	
34.5mm (1-11/32")	19-9040			SWC9040					34L			
34.5mm (1-11/32")	19-7437			SWC7437					34			
34.5mm (1-11/32")	19-35	A	35					560	35		B	
34.7mm (1-3/8")	22-35	A	35					560	35		B	
32mm (1-1/4")	19-555		LOCK					555	Roll D			

MT / AT series

Box Bottomers

32mm (1-1/4")	32-22	C	32					561	32		R	
34.7mm (1-3/8")	22-35	A	35					560	35		B	

Every EVERWIN tool is etched with a serial number that helps us backtrack when and where that tool was made and by which assembly line groups, it also helps us identify the product batch of components used in that tool when needed.

Hereunder is how to decipher the serial numbers on your EVERWIN tool.



A19200109M

Serial number example : A19200109M

A

Production line number this tool was built on.

19

Made in the year 2019.

200

This tool was built on the 200 day of 2019.

109

This tool was the 109th tool built on that product line that day.

M

Symbolizes this is a magnesium housing tool.
Standard aluminum housing tools have no marking.

NAILER & STAPLER SAFETY TRAINING

Made easy for you



EVERWIN's Safety Program for pneumatic nailers and staplers simplifies training, making it more accessible. Its core goal is to provide users with the knowledge and tools necessary for safe tool operation, thus enhancing workplace safety. The program includes the following material:

- **10-Minute YouTube Video:** Provides visual education on safe tool operation.
- **Safety Point Flyers:** Concise reference materials with key safety points.
- **Certificates:** Recognize employees who complete the safety training.
- **Posters:** Display visual reminders of safety guidelines in the work place.
- **Tracking Sheet:** Document employee participation in the program.



Flyers



Certificates



Posters



Scan this QR code to access this program

EVERWIN

TOUGHER FASTER SMARTER



EVERWIN PNEUMATIC | 

[everwinpneumatic.com](https://www.everwinpneumatic.com) 

sales@everwinpneumatic.com 